

Hi-Fi AMPLIFIER 22RH520

00/15/16

Service manual

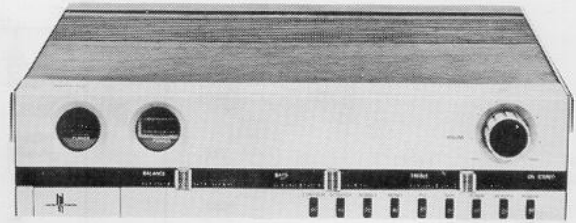

2534A

PHILIPS



(GB)	(NL)	(F)	(D)	(I)	
1 Left-hand power indicator	Vermogensindicator linker kanaal	Indicateur de puissance canal de gauche	1 Leistungsindikator des linken Kanals	Indicatore di potenza canale sinistro	IND401
2 Headphone socket	Hoofdtelefoonaansluiting	Douille écouteur	2 Kopfhöreranschluss	Presa auricolare	
3 Balance control	Balansregelaar	Commande de balance	3 Symmetrieregler	Equilibrio	R411a, b
4 Right-hand power indicator	Vermogensindicator, rechter kanaal	Indicateur de puissance canal de droite	4 Leistungsindikator des rechter Kanals	Indicatore di potenza canale destro	IND402
5 Bass control	Lagetonenregelaar	Commande des graves	5 Bassregler	Bassi	R409a, b
6 Recorder switch	Magnetofoonschakelaar	Comm. magnétophone	6 TB-Schalter	Comm. registratore	SK-A
7 Tuner switch	Tunerschakelaar	Comm. d'accord	7 Turnerschalter	Comm. d'accordo	SK-B
8 PU switch	PU-schakelaar	Comm. PU	8 TA-Schalter	Comm. giradischi	SK-D
9 Mono/stereo switch	Mono/stereoschakelaar	Comm. mono/stéréo	9 Mono/Stereo-Schalter	Comm. mono/stereo	SK-E
10 Physiology switch	Fysiologieschakelaar	Comm. physiologique	10 Fysiologie-Schalter	Comm. fisiologico	SK-F
11 Treble control	Hogetonenregelaar	Commande des aigus	11 Hochtonregler	Acuti	R410a, b
12 Scratch switch	Scratchschakelaar	Comm. scratch	12 Scratch-Schalter	Comm. scratch	SK-G
13 Rumble switch	Rumbleschakelaar	Comm. rumble	13 Rumble-Schalter	Comm. rumble	SK-M
14 Headphone switch	Hoofdtelefoonschakelaar	Comm. écouteur	14 Ohrhörer-Schalter	Comm. auricolare	SK-J
15 On/off switch	Aan/uit-schakelaar	Comm. marche/arrêt	15 Ein/Aus-Schalter	Interuttore marcia fermo	SK-K
16 Stereo indicator	Stereo-indicator	Indicateur stéréo	16 Stereo-Indikator	Indicatore stereo	LA419
17 On/off indicator	Aan/uit-schakelaar	Indicateur marche/arrêt	17 Ein/Aus-Indikator	Indicatore di rete	
18 Volume control	Volumeregelaar	Commande de volume	18 Lautstärkeregler	Controllo del volume	R408a, b
19 Rear loudspeaker socket	Luidsprekeeraansluiting achter	Connexion arrière du haut-parleur	19 Hinterer LS-Anschluss	Collegamento dietro altoparlante	
20 Front loudspeaker socket	Luidsprekeeraansluiting voor	Connexion avant du haut-parleur	20 Vorderer LS-Anschluss	Collegamento avanti altoparlante	
21 Tuner Stereo/stereo 4	Schakelaar stereo/stereo 4	Comm. stéréo/stéréo 4	21 Schalter Stereo/Stereo 4	Commutatore stereo/stereo 4	SK-N
22 Recorder socket	Magnetofonaansluiting	Prise magnétophone	22 TB-Anschluss	Presa registratore	
23 Tuner socket	Tuneraansluiting	Prise tuner	23 Tuner-Anschluss	Presa tuner	
24 PU socket	PU-aansluiting	Prise PU	24 TA-Anschluss	Presa giradischi	
25 PU switch (dynamic cristal)	PU-schakelaar, dyn/kristal	Comm. PU dyn/cristal	25 TA-Schalter (Dyn/Quarz)	Comm. giradischi din/cristallo	SK-M

Index: CS35413-CS35418



Subject to modification

4822 725 10996

Printed in the Netherlands

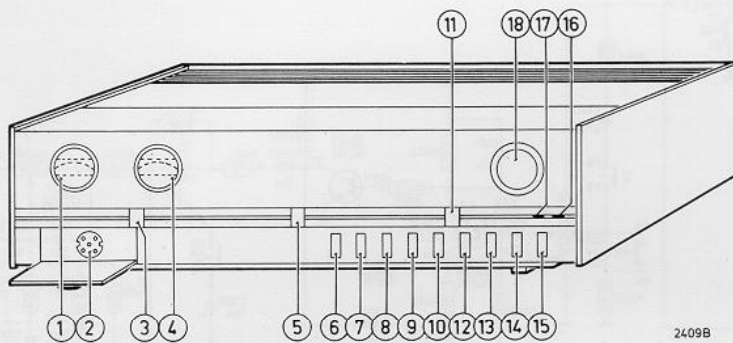

2409B

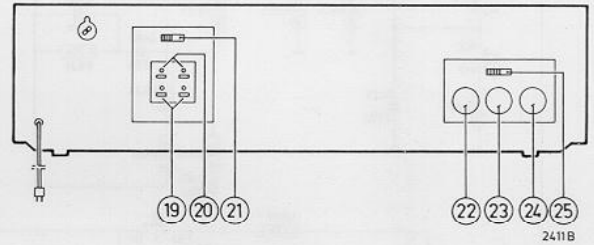

2411B

GB

S

DK

N

SF

1	Left hand power indicator	Effektindikator vänster	Venstre udstyrings indikator	1	Venstre effekt-indikator	Vasen tehoindikaattori	IND401
2	Headphone socket	Hörtelefonuttag	Hovedtelefon-tilslutning	2	Tilkoplingskontakt for hodetelefon	Kuulokepistukka	
3	Balance control	Balanskontroll	Balancekontroll	3	Balansekontroll	Tasaussäädin	R411a,b
4	Right hand power indicator	Effektindikator höger	Højre udstyrings-indikator	4	Høyre effekt-indikator	Oikea tehoindikaattori	IND402
5	Bass control	Baskontroll	Baskontroll	5	Basskontroll	Matakensäädin	R409a,b
6	Recorder switch	Båndopllar-omkopplare	Båndoptaker-omskifter	6	Båndoptaker-vender	Nauhurikytkin	SK-A
7	Tuner switch	Tuner omkopplare	Afstemning omskifter	7	Tuner-vender	Viritynkytkin	SK-B
8	PU-switch	PU-omkopplare	PU-omskifter	8	PU-vender	PU-kytkin	SK-D
9	Mono/stereo switch	Mono/stereo-omkopplare	Mono/stereo-omskifter	9	Mono/stereo-vender	Mono/stereo-kytkin	SK-E
10	Physiology switch	Fysiologiomkopplare	Fysiologi-omskifter	10	Vender for physiology	Fysiologiakytkin	SK-F
11	Treble control	Diskantkontroll	Diskantkontroll	11	Diskantkontroll	Korkeidensäädin	R410a,b
12	Scratch switch	Scratch-omkopplare	Scratch-omskifter	12	Vender for scratch	Sihinä-kytkin	SK-G
13	Rumble switch	Rumble-omkopplare	Rumble-omskifter	13	Vender for rumble	Jyrinä-kytkin	SK-H
14	Headphone switch	Hörtelefonomkopplare	Hovedtelefon-omskifter	14	Vender for hodetelefon	Kuuloketytkin	SK-J
15	On/off switch	Till/från omkopplare	Afbyder	15	På/av-vender	On/ei-kytkin	SK-K
16	Stereo indicator	Stereoindikator	Stereo-indikator	16	Stereoindikator	Stereoindikaattori	LA419
17	On/off indicator	Nät-indikator	Kontrolllys	17	Nettindikator	Verkkoindikaattori	
18	Volume control	Volymkontroll	Volumenkontroll	18	Volymkontroll	Voimakkuussäädin	R408a,b
19	Rear loudspeaker sockets	Högtalareuttag bak	Bageste højttaler-bøsninger	19	Bakre høyttaler uttak	Kovaaänispistukat takana	
20	Front loudspeaker sockets	Högtalareuttag fram	Forreste højttaler-bøsninger	20	Front høyttaler uttak	Kovaaänispistukat edessä	
21	Switch stereo/ stereo 4	Omkopplare stereo stereo 4	Stereo-omskifter/ stereo 4	21	Vender stereo/ stereo 4	Kytkin stereo stereo 4	SK-N
22	Recorder socket	Uttag bandspelare	Båndoptager-tilslutning	22	Tilkoplingskont. bånd-optaker	Nauhuripistukka	
23	Tuner socket	Uttag tuner	Tuner-tilslutning	23	Tilkoplingskont. tuner	Viritinpistukka	
24	PU socket	Uttag skivspelare	PU-tilslutning	24	Tilkoplingskont. plate-spiller	PU-pistukka	
25	PU switch dyn./ cristal	Gramm. magn./kristall	PU syn/kristal	25	PU magn./X-tall	Äänirasia dyn-kide	SK-M

M	TS 421		TS 422		TS 423		TS 424		TS 425		TS 426		TS 427		TS 428		S 465 S 466				TS 429 TS 430 LA17-LA20																													
C	475	477	479	485	483	481	487		493	495	497	501	503	505	507			517	511	515	513	521	523	525																										
C	476	478	480	486	484	482	488		494	496	498	502	504	506			508	518	512	516	514	566	565	522	524	564	526	536	553	555																				
R	601	605	603	613	621	623	629	607	615	609	627	611	639	635	633	637	633	641	631	643	645	651	653	408a	657	655	663	661	665	667	659	669	671	679	689	687	677	683	685	409a	410a	681	693	691	697	695	411a			
R	602	606	604	614	622	624	610	616	608	630	628	612	636	642	634	638	640	632	644	646	652	654	408b	658	656	664	662	666	668	660	670	672	778	777	680	690	688	678	684	686	409b	410b	682	694	692	698	696	411b	717	712

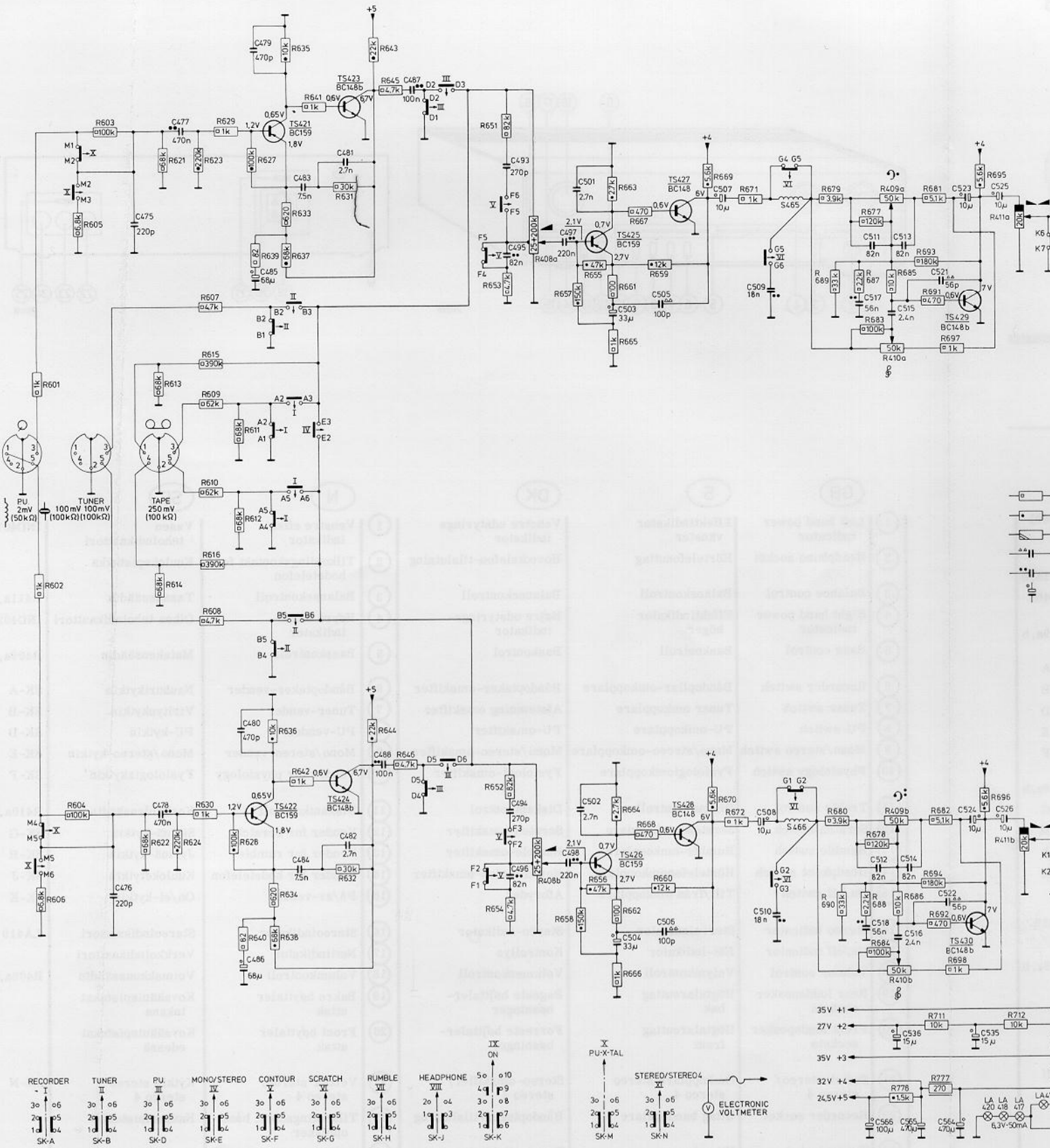

TS429	TS430	LA17+LA20	VL414	VL415	D462	D451+D454	TS431	TS432	S405	VL1	VL2	TS435	TS436	TS433	TS434	TS437b	TS437a	TS439b	TS439a	TS441b	TS441a	TS443b	TS443a	S463	S464	D457	D461	TS447	TS448	D456	D460	M										
513	521	523	525	531	529	533	539	537	543	541	547	551	557	561	562	564	568	567	538	544	542	548	552	558	562	562	562	562	562	562	562	562	C									
514	566	565	522	524	564	526	536	535	553	554	563	532	530	534	540	568	567	538	544	542	548	552	558	562	562	562	562	562	562	562	562	562	C									
409a	410a	681	693	691	697	695	411a	701	703	709	705	715	707	719	721	713	733	727	729	731	723	735	717	737	739	741	747	751	749	753	755	757	768	763	769	770	765	761	767	786	R	
409b	410b	682	694	692	698	696	411b	710	712	716	717	718	719	720	721	714	734	728	730	732	724	736	718	738	740	742	748	752	750	754	756	764	758	772	773	774	766	762	771	787	785	R

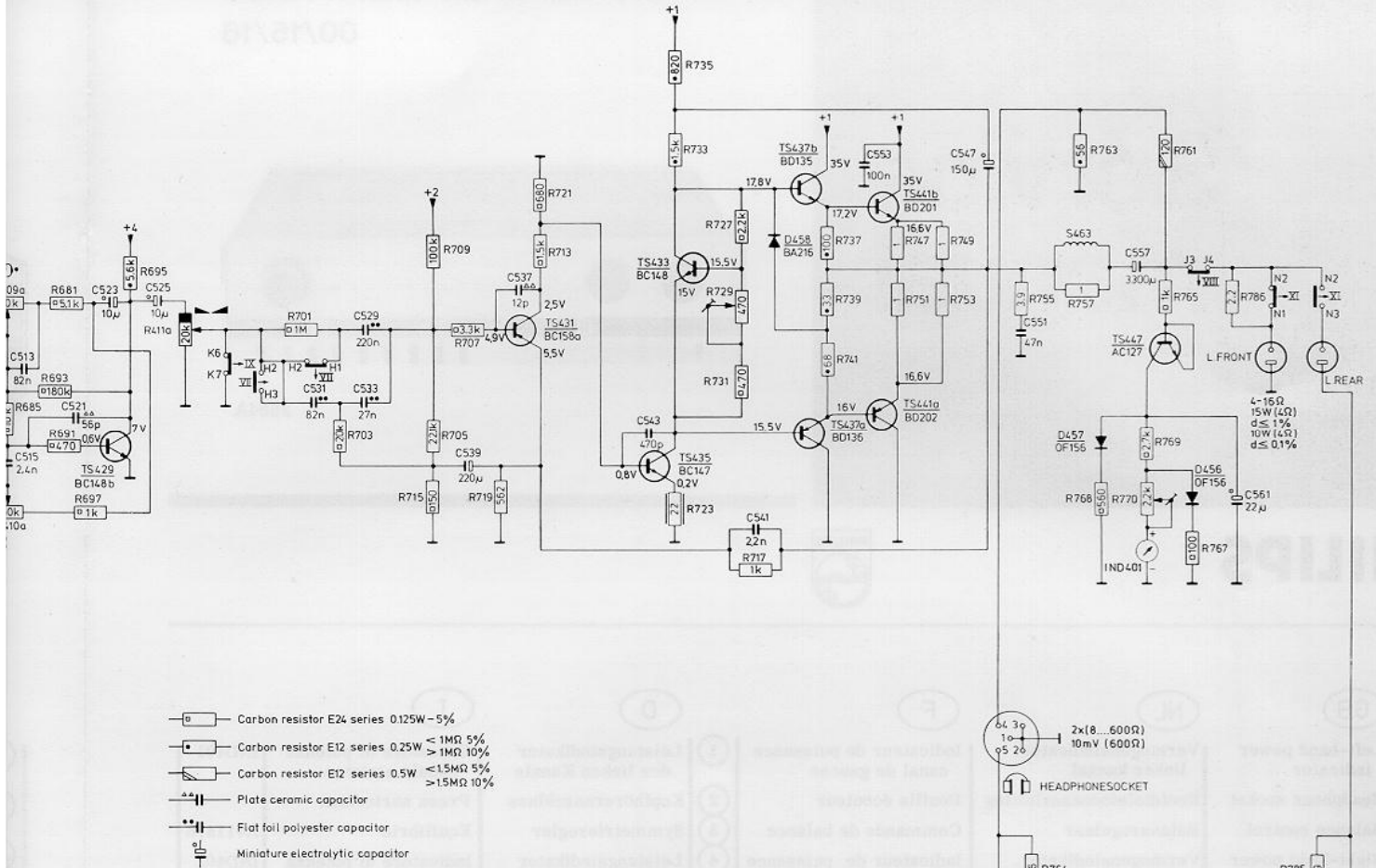

- Carbon resistor E24 series 0.125W - 5%
- Carbon resistor E12 series 0.25W $\le 1M\Omega$ 5% $\le 1M\Omega$ 10%
- Carbon resistor E12 series 0.5W $\le 1.5M\Omega$ 5% $> 1.5M\Omega$ 10%
- Plate ceramic capacitor
- Flat foil polyester capacitor
- Miniature electrolytic capacitor

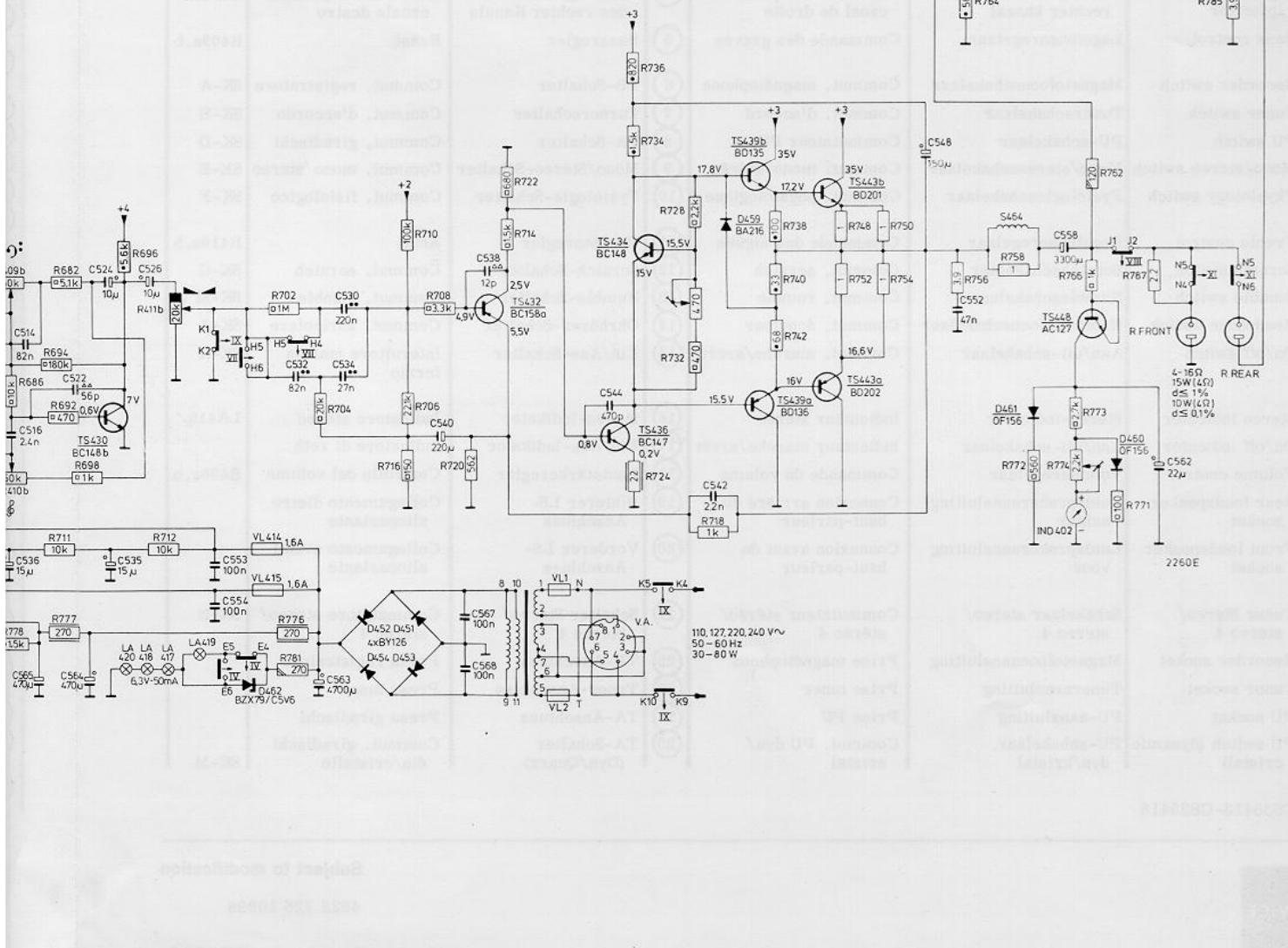

2250E

MISC	R	R	C	C
TS422	630	644	478	484
424	528	640	480	482
423	624	640	476	488
TS421	634	642		566
602	645	631	487	
602	641	631	483	
623	631	643	477	481
629	637		475	486
601	606	778	485	
603	606			
605	612			
607	609			
614				
613				
616				
609				
				502
				565
TS437a	723	713	497	
431	721	663	501	
425	741	664	501	
426	707	657	551	
435	755	666	543	
441a	719	668		
	709	665		
	732	658		
	753	661	503	
	751	662	504	
D458	731	659	529	
TS425	727	667	533	
	667	669	505	
TS428			539	506
TS433	703	670		
	757			
TS437b	712	670	507	
S463	711	672	535	
466				
465				
441b				
				511
				508
				536
	737	679	531	
	749	677	531	
	747		547	
TS439b				513
	736	681		
	750	697		
	738	695		
	748			
TS443b	728	683	548	
434	732			
S464	730	615	523	
D459	718		525	
			514	
			521	
TS429	758	685	542	
	740	691	540	
	742	693		
	720	687		
TS439a	716	616		
	754			
SK-A	704	680		
TS432	752	706	544	
436	756	678		
	714	680		
	710	680		
TS443a	708	652	552	
D457	768	694	524	
SK-B	722	698	534	
D456	724	767	532	
			494	
VL415			496	
TS447	770	765	561	
			530	
			526	
SK-D	769	684	562	
TS448	773	654	526	
D460		692	522	
VL414	774	688		
TS430	772	690		
	771	651	518	
D461	771	776	568	493
			567	
SK-E				495
D451				510
D454		653		564
D462				
				509
		702		
SK-F		701		
				563
SK-G		781		
				558
SK-H		763		
		764		
				557
SK-J		761		
		762		
SK-K				
				05 04
				03 02 01
				08 07 06
MISC	R	R	C	C

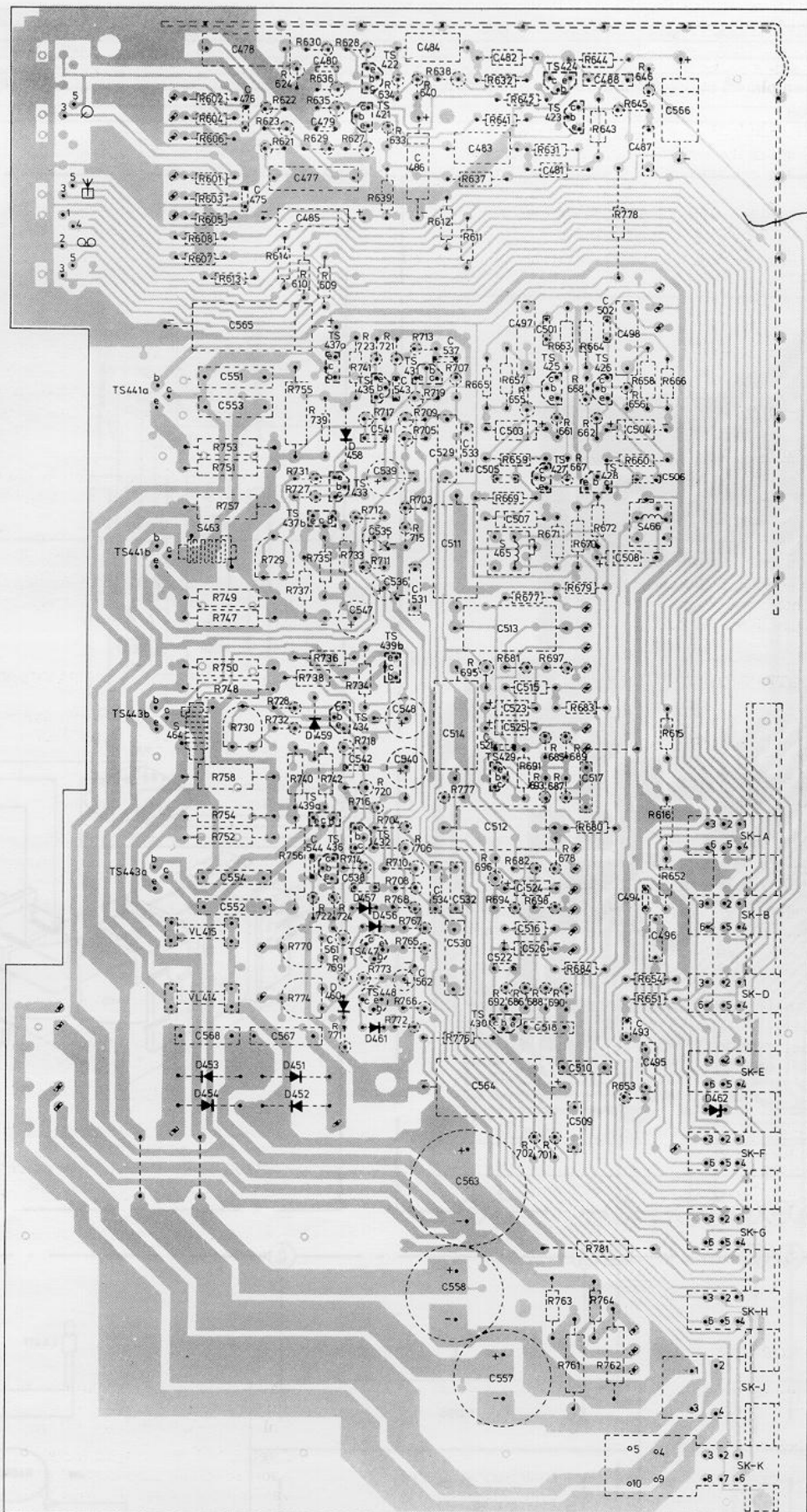

2404D

TS421-TS436



TS437a, b
TS439a, b

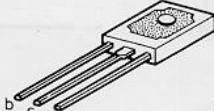

TS441a, b
TS443a, b

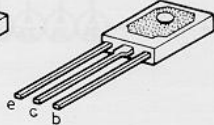

TS447, 448

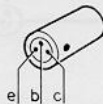

D456, 457
D460, 461

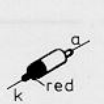

D458, 459

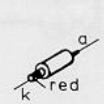

D462

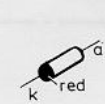

D451-454

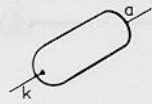

GB REPAIR HINTS

- The track sides of the p.c. boards have been drawn after the set had been placed on its right side (stable position).

Electrical adjustments

Immediately after the set has been switched on with R729, R730, adjust the currents of VL414 and VL415 to 250 mA d.c. $\pm 5\%$.

Check after 5 minutes and readjust if necessary.

The currents must now be 250 mA d.c. $\pm 10\%$.

Set the pointers of IND401 and IND402 to the middle of the scale with R770 and R774 respectively if on the output resistor (4 Ω) 1.4 V a.c. (1000 Hz) is measured.

F INSTRUCTIONS POUR LA REPARATION

- Les traces imprimées des platines ont été dessinées alors que l'appareil était posé sur le côté droit (position stable).

Réglages électriques

Dès que l'appareil est mis en marche:

à l'aide de R729, R730, régler les courants de VL414 et VL415 sur 250 mA $\pm 5\%$.

Vérifier après 5 minutes et ajuster au besoin.

Les courants doivent alors être de 250 mA $\pm 10\%$.

Positionner l'index de IND401 et IND402, à l'aide de R770 ou de R774 au centre du cadran lorsqu'on mesure 1.4 V \sim (1000 Hz) à la résistance de sortie (4 Ω).

I ISTRUZIONI PER LA RIPARAZIONE

- Le traccie stampate delle piastre sono state raffigurate in posizione dell'apparecchio sul fianco destro (posizione stabile).

Regolazioni elettriche

Dal momento che l'apparecchio è messo in marcia: con R729, R730 regolare le correnti di VL414 e VL415 su 250 mA $\pm 5\%$.

Dopo 5 minuti, verificare e aggiustare se necessario.

Le correnti devono essere ora 250 mA $\pm 10\%$.

Mettere l'indice di IND401 e IND402 con l'aiuto di R770 o di R774 in mezzo alla scala quando alla resistenza di uscita (4 Ω) si misura 1.4 V \sim (1000 Hz).

DK REPARATIONSTIPS

- Printpladerne er vist med apparatet anbragt på sin højre side (stabil stilling).

Elektriske justeringer

Straks efter at apparatet er tilsluttet spænding, justeres strømmene for VL414 og VL415 til 250 mA $\pm 5\%$, ved hjælp af R729 og R730.

Efter ca 5 min. forløb kontrolleres strømmene, og om fornøden foretages efterjustering.

Strømmen må herefter være 250 mA $\pm 10\%$.

Indstil IND401 og IND402 til udslag midt på skalaen ved hjælp af henholdsvis R770 og R774 når der måles 1,4 V a.c. (1000 Hz) over udgangsmodstanden (4 Ω).

SF KORJAUSVIHJEITÄ

- Piirilevyjen foliopoilet on piiretty kun laite sijaitsee oikealla kyljellään.

Sähköiset säädöt

Välittömästi kun laite on kytketty päälle säädetään R729:lla ja R730:lla VL414:b:n ja VL415:b:n kollektorivirrat arvoon 250 mA d.c. $\pm 5\%$.

NL REPARATIEWENKEN

- De spoorzijde van de printen zijn getekend terwijl het apparaat op zijn rechterzijwand staat (stabiel stand).

Elektrische instellingen

Direkt na inschakelen van het apparaat:

M.b.v. R729, R730 de stromen van VL414 resp. VL415 instellen op 250 mA $\pm 5\%$.

Controle na 5 minuten (eventueel bijregelen):

De stromen moeten nu 250 mA $\pm 10\%$ bedragen.

De wijzers van IND401 en IND402 m.b.v. R770 resp. R774 instellen op het midden van de schaal indien over de uitgangsweerstand (4 Ω) 1.4 V \sim (1000 Hz) wordt gemeten.

D REPARATURHINWEISE

- Die Spurseiten der Printplatten wurden gezeichnet, während das Gerät auf der rechten Seitenwand stand (stabile Stellung).

Elektrische Einstellungen

Stelle direkt nach Einschalten des Geräts:

die Ströme von VL414 bzw. VL415 mit R729, R730 auf 250 mA $\pm 5\%$.

Kontrolliere nach 5 Minuten (ggf. nachjustieren).

Die Ströme müssen jetzt 250 mA $\pm 10\%$ betragen.

Stelle die Zeiger von IND401 und IND402 mit R770 bzw. R774 auf Skalenmitte, wenn am Ausgangswiderstand (4 Ω) 1.4 V \sim (1000 Hz) gemessen wird.

S REPARATIONSANVISNING

- Foliesidorna på printarna har ritats efter det att apparaten har ställts på sin högra sida.

Elektriska justeringar

Justera genast efter tillkoppling strömmarna i VL414 och VL415 till 250 mA $\pm 5\%$.

Justering sker med R729 och R730. Kontrollera och justera vid behov efter 5 minuters drift. Strömmarna skall då vara 250 mA $\pm 10\%$.

Ställ visarna på IND401 och IND402 till skalans mitt med R770 och R774 när spänningen över utgångsmotståndet (4 Ω) är 1,4 V a.c. (1000 Hz).

N REPARASJONSTIPS

- Loddessiden til printplaten er tegnet etter at apparatet er plassert på sin høyre side (stabil posisjon).

Elektriske justeringer

Umiddelbart etter at apparatet er slått på, justér med R729, R730 strømmen til VL414 og VL415 til 250 mA d.c. $\pm 5\%$.

Kontrollér etter 5 minutter og rejustér igjen om nødvendig. Strømmen må nå være 250 mA d.c. $\pm 10\%$.

Innstill viserne på IND401 og IND402 til midten av skalaen med R770 reps. R774 om det måles 1,4 V a.c. (1000 Hz) over utgangsmotståndet (4 Ω).

Tarkasta 5 min:n käytön jälkeen ja säädä uudelleen tarpeen vaatiessa.

Kollektorivirtojen tulee nyt olla 250 mA d.c. $\pm 10\%$.

Aseta R770 ja R774:llä indikaattoreiden IND401 ja IND402 osoittimet asteikon keskelle kun pääteaste on päätetty 4 Ω :n vastuksella ja sen navoissa on 1,4 V a.c. (1000 Hz).

MISC	TS421,422	SK-M	TS437a,435,441a	D458	TS433,437b	TS441b, S463	TS439b,434,443b,S464,D459	TS439a,432,436,443a	D457,456,VL415,414	TS447,448	D460,461,451+454
R	6306,24,62,3,62,2,60,2,60,4,60,6,62,16,29,60,1,60,3,60,5+60,8,61,6,10,6,13,60,9		IND402 LA418 TS431	TS425+428	S466 S465		TS429	SK-A	SK-B SK-D TS430	SK-E D462	SK-F
R	628, 632,636,634,638,635,640,633,641,627,637,639,612,611		663,664	658,666,656,668,655,660+662,667,670,411a,b,671,679,677,672		755,739,753,751,731,727,757,729,735,737,749,747,738,750,748,728,732,730,742,740,758	754,752,756	722,724,770,769,774,771,			
R	644,646 642 643 645,631	778				736,695,734	718,691,777,720,716,704,706,710,696,714,708,768,694,767,765,773,766,692,772,776				
C	478 480 476,479 477 475,485		565	551,543,553 541 539	535 536 547	681,697	683,615,685,689,693,687,616,680	678,682,652,698	684,654,651,686,688,690,409a,b,653 702,701	567 568	
C	484,482 488 566 483 487 481,486		501,498,497 502,537	503,504,529 533 505+507 511 508 531 513		515 523 514 525 521 517	512 494 534,532,524,516,496,526,530,522,562,493,518, 495,510	564,509 563			

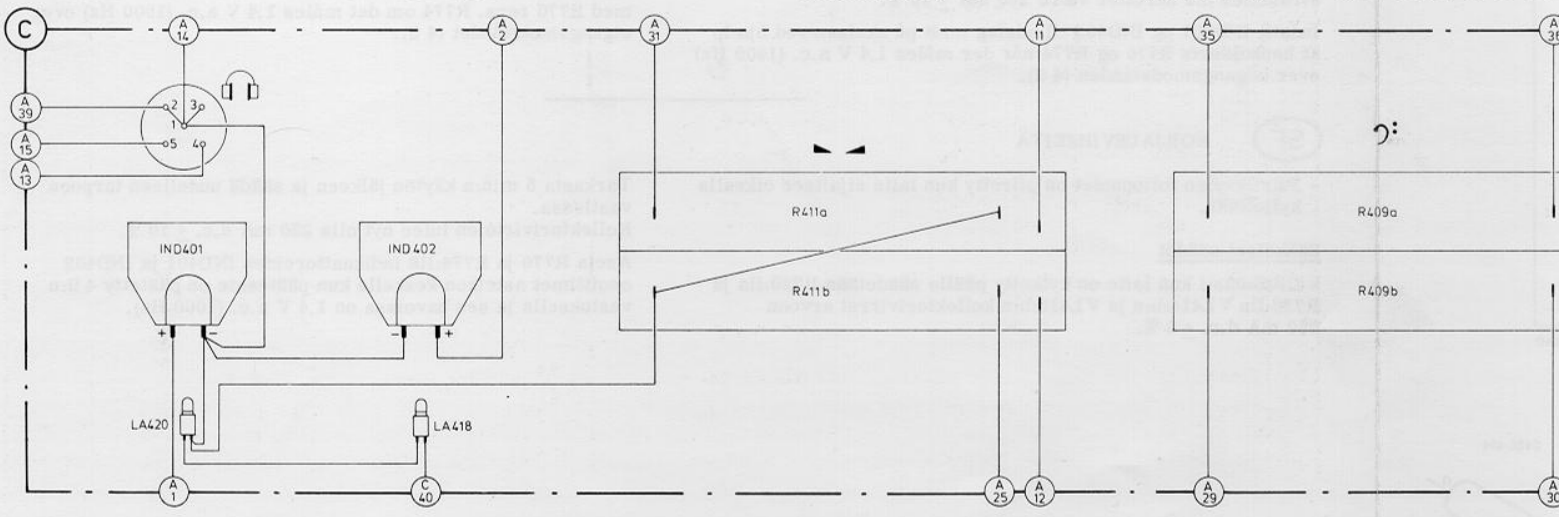
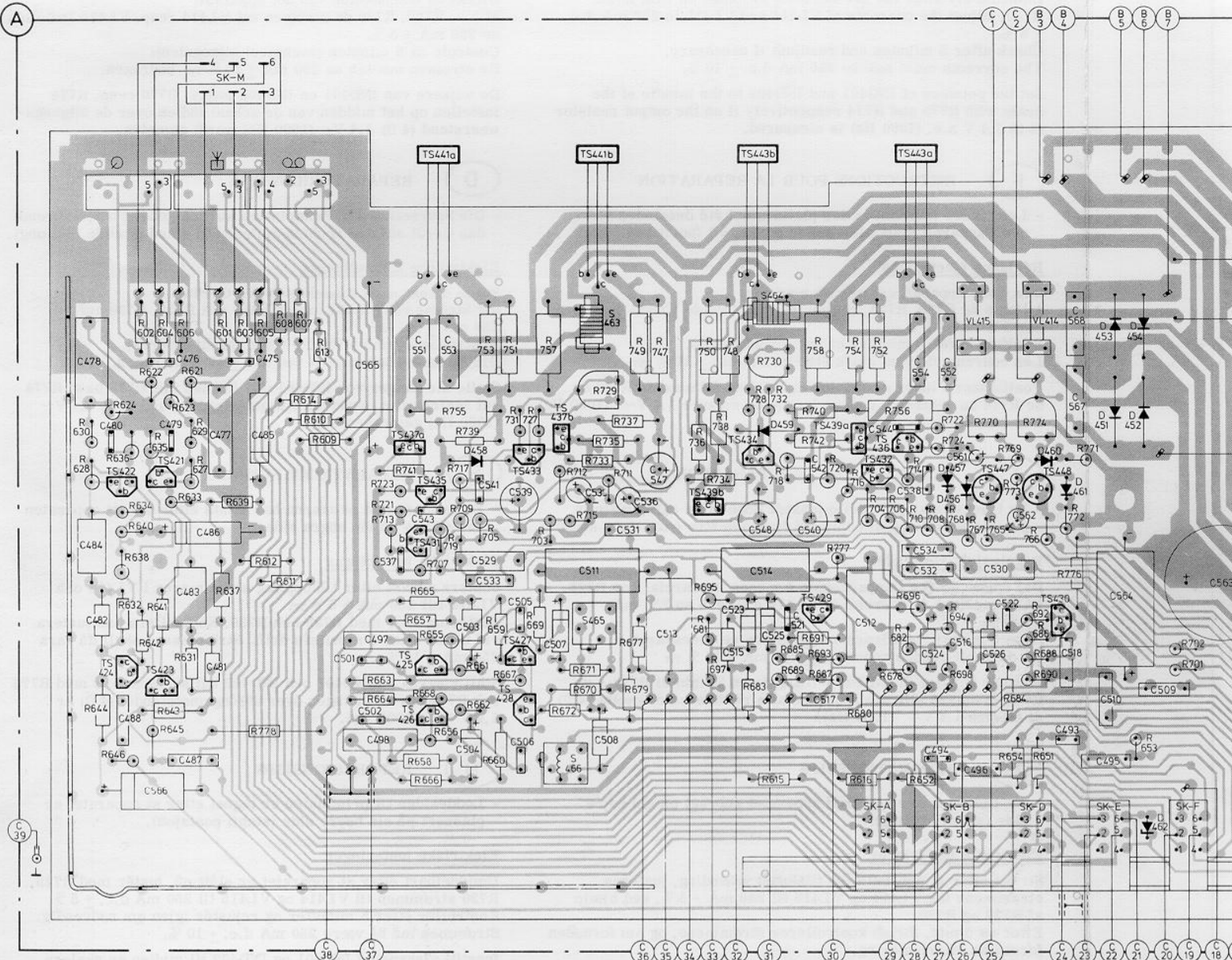

15.414 TS447.443 D460.461.451+454	SK-N										MISC	
-D TS430 SK-E D462 SK-F SK-G SK-H SK-J SK-K	VL1	VA	S405								MISC	
9.774. 771.	785+787	LA417	LA419								R	
765.773.766.692.772.776											R	
654.651.686.688.690.4.09a.b.653 702701	781	761-764	410a.b								408a.b	R
567 558											C	
30.522.562.493.518. 495.510 564.509 563	558	557									C	

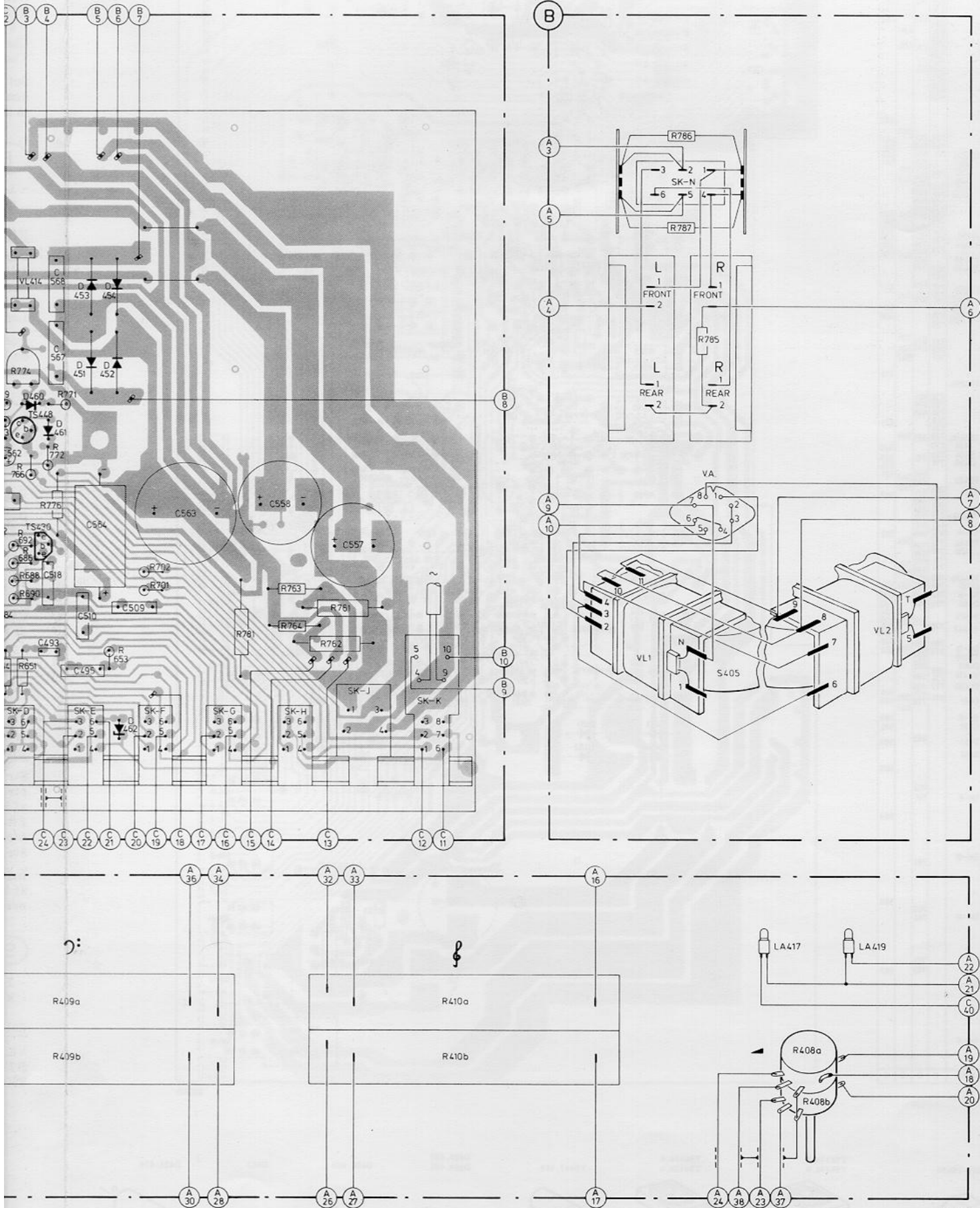

(GB)

Lamp holder
Fuse holder
Socket, loudspeaker
Plug loudspeaker
Socket (5 poles 180°)
Plug (5 poles 180°)
Plug (headphone)
Insulation tube power transistor
Insulation plate power transistor
Silicon grease
Switch unit
Switch (loudspeaker PU dyn./cristal)
Power indicator IND401
Power indicator IND402

(NL)

4822 255 10007
4822 492 60063
4822 267 50194
4822 264 30041
4822 267 40133
4822 264 40023
4822 264 40092
4822 255 40111
4822 255 40112
4822 390 20023
4822 276 80101
4822 277 20091
4822 347 10103
4822 347 10104

Lampouder
Smeltveiligheidshouder
Aansluiting luidspreker
Steker luidspreker
Aansluiting (5 polig 180°)
Steker (5-polig 180°)
Steker (hoofdtelefoon)
Isolatiebus eindtransistor
Isolatieplaat eindtransistor
Silicon vet
Schakelaareenheid
Schakelaar (luidspreker PU dyn./kristal)
Vermogenindikator IND401
Vermogenindikator IND402

(F)

Support de lampe
Porte-fusible
Prise (haut-parleur)
Fiche (haut-parleur)
Prise (5-pôles 180°)
Fiche (5-pôles 180°)
Fiche (casque)
Douille d'isolation (transistor final)
Plaqué d'isolation (transistor final)
Graisse aux silicones
Bloc commutateur
Commutateur (haut-parleur PU dyn./cristal)
Indicateur de puissance IND401
Indicateur de puissance IND402

(D)

Lampenfassung
Schmelzsicherungshalter
Anschluss (Lautsprecher)
Stecker (Lautsprecher)
Anschluss (5polig 180°)
Stecker (5-polig 180°)
Stecker (Kopfhörer)
Isolierbuchse (Endtransistor)
Isolierplatte (Endtransistor)
Siliconfett
Schaltereinheit
Schalter (Lautsprecher TA dyn./Quarz)
Leistung Indikator IND401
Leistung Indikator IND402

(I)

4822 255 10007
4822 492 60063
4822 267 50194
4822 264 30041
4822 267 40133
4822 264 40023
4822 264 40092
4822 255 40111
4822 255 40112
4822 390 20023
4822 276 80101
4822 277 20091
4822 347 10103
4822 347 10104

Portallampada
Portafusibile
Presa (altoparlante)
Spina (altoparlante)
Presa (5-poli 180°)
Spina (5-poli 180°)
Spina (cuffia)
Tubo isolante (transistor finale)
Piastra isolante (transistor finale)
Lubrificante ai siliconi
Unità commutatore
Commutatore altoparlante PU dinamico/cristallo
Indice di potenza IND401
Indice di potenza IND402

(GB)

Lamp holder
Fuse holder
Socket loudspeaker
Plug loudspeaker
Socket (5 poles 180°)
Plug (5 poles 180°)
Plug (headphone)
Insulation tube
(power transistor)
Insulation plate (power transistor)
Silicon grease
Switch unit
Switch (loudspeaker PU dyn./cristal)
Power indicator IND401
Power indicator IND402

(S)

4822 255 10007
4822 492 60063
4822 267 50194
4822 264 30041
4822 267 40133
4822 264 40023
4822 264 40092
4822 255 40111
4822 255 40112
4822 390 20023
4822 276 80101
4822 277 20091
4822 347 10103
4822 347 10104

Lamphållare
Säkringshållare
Högtalaruttag
Plugg, högtalare
Uttag (5 poligt 180°)
Kontaktplugg (5 poligt 180°)
Hörtelefonplugg
Isoleringrör
(effekttransistor)
Isoleringsbricka
(effekttransistor)
Silikonfett
Slidomkopplarenhet
Omkopplare (högtalare - PU dyn./kristall)
Effektindikator IND401
Effektindikator IND402

(DK)

Lampeholder
Sikringsholder
Bøsning for højttaler
Højttalerstik
Bøsning (5-polet 180°)
Stik (5-polet 180°)
Hovedtelefonstik
Isolationsrør (udgangs-transistor)
Isolationsplade (udgangs-transistor)
Silikonfett
Skydeomskifterenhed
Omskifter (højttaler - PU dyn./kryst.)
Udstyringsindikator IND401
Udstyringsindikator IND402

(N)

Lampeholder
Sikringsholder
Kontakt for høyttaler
Høyttalerplugg
Kontakt (5-polet 180°)
Plugg (5-polet 180°)
Øretelefonplugg
Isolasjonshylse
(krafttransistor)
Isolasjonsplate
(krafttransistor)
Siliconfett
Sleidevender enhet
Vender høyttaler - PU dyn./krystall
Effektindikator IND401
Effektindikator IND402

(SF)

4822 255 10007
4822 492 60063
4822 267 50194
4822 264 30041
4822 267 40133
4822 264 40023
4822 264 40092
4822 255 40111
4822 255 40112
4822 390 20023
4822 276 80101
4822 277 20091
4822 347 10103
4822 347 10104

Lampunidin
Sulakepidin
Kaiutinpistukka
Koväänispistike
Pistukka (5 napaa 180°)
Pistike (5 napaa 180°)
Kuulokkeiden pistike
Eristysputki
(tehotransistori)
Eristyslevy
(tehotransistori)
Silikonirasvaa
Luukukytinkyksikkö
Kytkin (kovaääninen - PU dyn./kide)
Tehoindikaattori IND401
Tehoindikaattori IND402

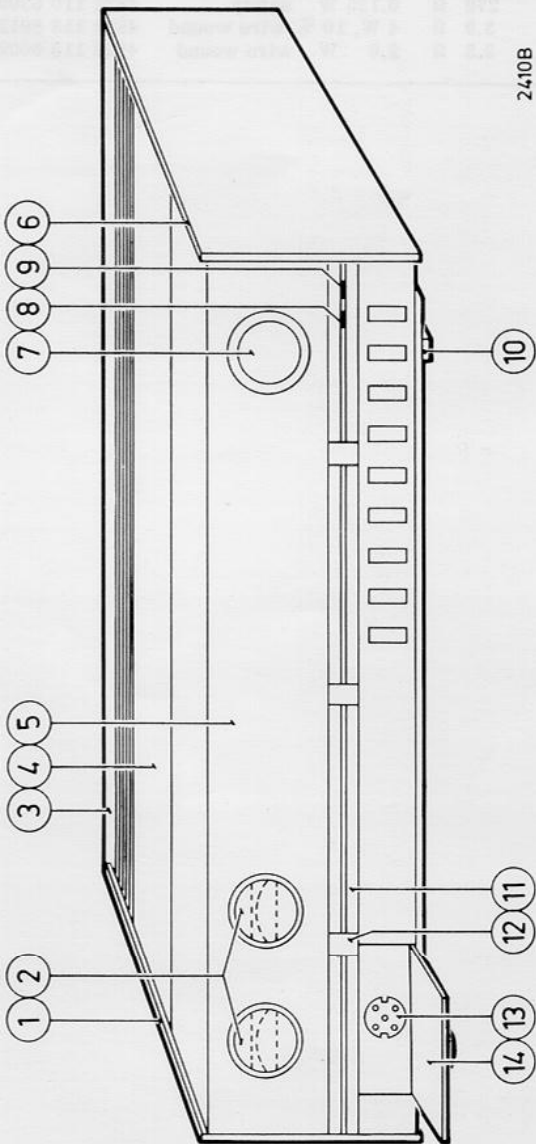

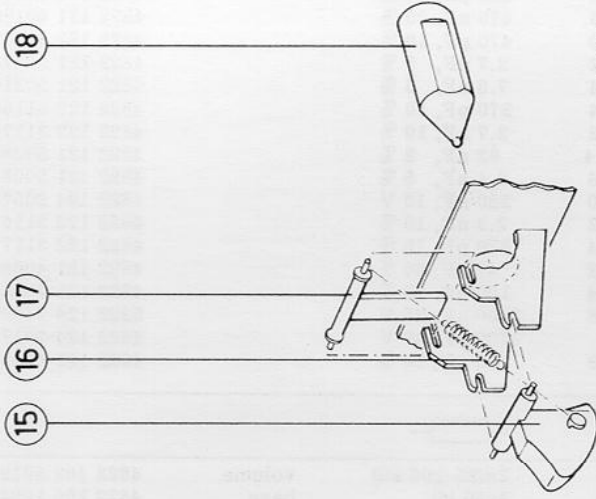

2410B



2406A

- 1 4822 426 30038
- 2 4822 450 60101
- 3 4822 460 10336
- 4 4822 426 40029
- 5 4822 426 50136
- 6 4822 426 30035
- 7 4822 413 50807
- 8 4822 381 10385
- 9 4822 381 10384
- 10 4822 462 70869
- 11 4822 454 10342
- 12 4822 411 60243
- 13 4822 267 40215
- 14 4822 454 10317
- 15 4822 411 50277
- 16 4822 492 31088
- 17 4822 404 10206
- 18 4822 535 90931

/Z
walnut

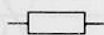
-TS- 			-C- 		
TS421,422	BC159	4822 130 40508	C475,476	220 pF, 10 %	4822 122 31173
TS423,424	BC148b	4822 130 40318	C477,478	470 nF, 20 %	4822 121 40186
TS425,426	BC159	4822 130 40508	C479,480	470 pF, 10 %	4822 122 31177
TS427,428	BC148	4822 130 40318	C481,482	2.7 nF, 5 %	4822 121 50474
TS429,430	BC148b	4822 130 40318	C483,484	7.5 nF, 5 %	4822 121 50214
TS431,432	BC158a	4822 130 40614	C493,494	270 pF, 10 %	4822 122 31168
TS433,434	BC148	4822 130 40318	C501,502	2.7 nF, 10 %	4822 122 31174
TS435,436	BC147	4822 130 40333	C511+514	82 nF, 2 %	4822 121 50288
TS437a,b	BD135/136	4822 130 40866	C515,516	2.4 nF, 5 %	4822 121 50081
TS439a,b	BD135/136	4822 130 40866	C539,540	220 μF, 10 V	4822 124 20573
TS441a,b	BD201/202	4822 130 40943	C541,542	2.2 nF, 10 %	4822 122 31167
TS443a,b	BD201/202	4822 130 40943	C543,544	470 pF, 10 %	4822 122 31177
TS447,448	AC127	4822 130 40096	C551,552	47 nF, 20 %	4822 121 40055
			C553,554	100 nF, 20 %	4822 121 40059
			C557,558	3300 μF, 25 V	5322 124 74036
			C563	4700 μF, 40 V	4822 124 70173
			C567,568	100 nF, 20 %	4822 121 40059
-D- 			-R- 		
D451+454	BY126	4822 130 30192	R408a,b	2x(25+200 kΩ)	volume 4822 102 30199
D456,457	OF156	4822 130 30265	R409a,b	2x50 kΩ	bass 4822 105 10043
D458,459	BA216	4822 130 30702	R410a,b	2x50 kΩ	treble 4822 105 10043
D460,461	OF156	4822 130 30265	R411a,b	2x20 kΩ	balance 4822 105 10044
D462	BZX79/C5V6	4822 130 30759	R705,706	22.1 kΩ 0.4 W	metal film 4822 116 50648
Miscellaneous			R709,710	100 kΩ 0.4 W	metal film 4822 116 51089
S405	Mains transformer	4822 146 20488	R711,712	10 kΩ 0.125 W	2 % 4822 110 63134
S463,464		4822 157 50718	R717,718	1 kΩ 0.5 W	metal film 5322 116 54207
S465,466		4822 156 10346	R719,720	562 Ω 0.4 W	metal film 5322 116 51063
VL1-2		4822 252 20007	R723,724	22 Ω 0.125 W	safety 4822 110 63063
VL414,415	1.6 A	4822 253 20022	R729,730	470 Ω	trim pot.meter 4822 100 10038
LA417+420	6.3 A, 50 mA	4822 134 40003	R747-754	1 Ω 0.5 W	4822 110 43027
			R755,756	3.9 Ω 1 W	4822 110 23043
			R757,758	1 Ω 1 W	4822 110 23027
			R770,774	2.2 kΩ	4822 100 10029
			R776,777	270 Ω 0.125 W	safety 4822 110 63092
			R785	3.9 Ω 4 W, 10 %	wire wound 4822 113 80129
			R786,787	2.2 Ω 2.6 W	wire wound 4822 113 60028

Service
Service
Service



7790A

Service Manual

(GB) See Service Manual of 22RH520/00-
However the following code numbers are
different:

Top panel	4822 426 40068
Strip	4822 460 10372
Front	4822 426 50185
Headphone cover	4822 426 60095
Right-hand side panel	4822 426 30067
Left-hand side panel	4822 426 30066

(F) Voir Documentation Service du 22RH520/00
les codes suivants sont cependant différents:

Panneau supérieur	4822 426 40068
Langnette	4822 460 10372
Front	4822 426 50185
Couvercle prise écouteur	4822 426 60095
Panneau latéral droit	4822 426 30067
Panneau latéral gauche	4822 426 30066

(I) Vedere Documentazione di Servizio del
22RH520/00 Quindi, i seguenti codici sono
differenti:

Pannello superiore	4822 426 40068
Striscia decorative	4822 460 10372
Frontale	4822 426 50185
Coperchio presa cuffia	4822 426 60095
Pannello laterale destro	4822 426 30067
Pannello laterale sinistro	4822 426 30066

(DK) Se service Manual for 22RH520/00 imidlertid
er følgende varenumre afvigende:

Toppanel	4822 426 40068
Strip	4822 460 10372
Front	4822 426 50185
Hovedtelefon-daeksel	4822 426 60095
Højre sidepanel	4822 426 30067
Venstre sidepanel	4822 426 30066

(NL) Zie dokumentatie 22RH520/00 echter:

Bovenplaat	4822 426 40068
Strip	4822 460 10372
Front	4822 426 50185
Koptelefoon klep	4822 426 60095
Rechter zijpaneel	4822 426 30067
Linker zijpaneel	4822 426 30066

(D) Siehe Dokumentation 22RH520/00
Jedoch:

Obere platte	4822 426 40068
Streifen	4822 460 10372
Front	4822 426 50185
Kopfhörerklappe	4822 426 60095
Rechte Seitenplatte	4822 426 30067
Linke Seitenplatte	4822 426 30066

(S) Se Service Manual 22RH520/00 men följande
kodnummer är ändrade:

Överdel	4822 426 40068
List	4822 460 10372
Front	4822 426 50185
Lucka för lörtelefon- uttag	4822 426 60095
Höger gavel	4822 426 30067
Vänster gavel	4822 426 30066

(N) Se 22RH520/00 Service Manual semicolon
imidlertid avviker følgende kodenummere
colon:

Topp panel	4822 426 40068
Stripe	4822 460 10372
Front	4822 426 50185
Hodetelefon deksel	4822 426 60095
Høyre sidepanel	4822 426 30067
Venstre sidepanel	4822 426 30066

(SF) Katso 22RH520/00 huolto-ohjeesta seuraavien osien kohdalta ovat varaosakoodinumerot erilaiset:

Kansi	4822 426 40068
Lista	4822 460 10372
Etu-(seinä)	4822 426 50185
Kuuloketilan kansi	4822 426 60095
Oikea sivuseinä	4822 426 30067
Vasen sivuseinä	4822 426 30066

